

Model # 9380 / 9385

Installation Instructions



STEP 1 – SITE PREPARATION

RETROFIT INSTALLATION: (ATM is already in place)

Tuck fit: (surround rear panel tucks behind the ATM trim)

1. The ATM must be moved 1/4" (or as required) forward at the base, which creates a 1/4" gap behind the trim to allow surround to tuck behind ATM trim bezel.
2. Remove the ATM fascia or outer trim bezel, being aware of alarm systems which may be triggered if alarm is not shut off. If unfamiliar, have a qualified mechanic remove and replace the trim bezel.
3. Proceed to step 2.

Slip fit: (surround slips over outside of ATM trim bezel)

1. Machine does not move.
2. Trim bezel remains in place.
3. Proceed to step 2.

NEW INSTALLATION: (ATM is installed with surround.)

Tuck Fit: (surround rear panel tucks behind the ATM trim)

1. If the ATM wall opening is already provided, proceed to #2. Otherwise refer to the ATM manufactures specification.
2. Surround should be installed before the ATM so that the ATM trim bezel can be placed over the surround when the ATM is set. If the ATM is installed first, it must be set 1/4" out from the outside wall surface to allow for the surround back panel to tuck behind the trim.
3. Proceed to step 2.

Slip fit: (surround slips over outside of ATM trim bezel):

1. Same as tuck fit installation instructions above.

STEP 2 – UNPACKING AND HANDLING

While transporting, uncrating, and handling, do not set the unit face against any obstruction without the appropriate padding.

TOOLS AND SUPPLIES LIST:

1. Tape measure and pencil for marking wall
2. Level
3. Appropriate wall anchors:
 - a. (8) 1-1/4" x 1/4" lag screws into 1/2" O.D. lead anchors for masonry
 - b. 1/4" butterfly bolts for stucco etc. as required
4. Small socket set if using lag screws
5. Drilling Equipment for 1/2" anchor holes in wall
6. Fluorescent tubes (see decal on light fixture inside sign cabinet)
7. Rags and spray cleaner

STEP 3 – INSTALLATION

1. **Access for wall marking:** Find the suction cup in the waste can and use it to remove the sign face by grasping the sign face at the upper right corner and pulling outward until you can insert your fingers behind the sign face to pull it all the way out. Carefully set the sign face out of harm's way. Find top brackets connected to the bottom chair clips, attached to the bottom of the surround, and remove them for a later step.
2. **Positioning and marking for top brackets:** Two workmen hold the surround up and in place so it aligns with the ATM or ATM wall opening. Place a level on the writing surface to level the surround. A workman then reaches through the front of the upper sign cabinet and marks the wall around the two large horizontal slots in the metal back. Alternate: Using the ATM hole opening as a reference, measure from the opening to the top of the surround. A workman then transfers and marks the wall where the top of the surround will be. Using a straight edge, mark a second line 1 3/4" below the first line.

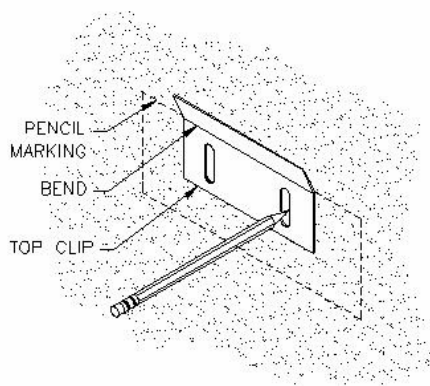

Through Sign Method

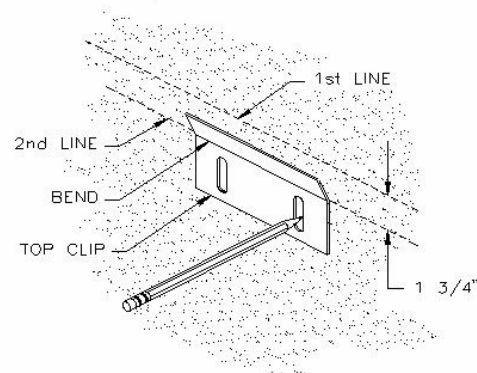

Alternate Method

- 3. Installing top brackets:** Find the top brackets and use one as a marking template by holding the bracket on the pencil line as shown and marking around both slots. Repeat for the other top bracket. Drill the wall at the center of the slot marks for appropriate connectors and mount the brackets. (Use 1-1/4" x 1/4" lag screws into 1/2" O.D. lead plugs for masonry; 1/4" butterfly bolts for stucco, etc.) Connectors are furnished by installer. Use washers under the connector heads.
- 4. Installing the bottom chair clip:** With one workman on each side of the surround, lift and hang it in place using a downward clipping motion to connect over the top brackets. Check the alignment of the surround opening over the ATM wall opening and check that it is level. Make any necessary adjustment by sliding the unit side to side or by loosening the top clips and correcting up or down.

Feed the electrical cord through the ATM opening if the plug will fit along side the ATM. If not, widen the ATM hole in one small spot to allow the plug to pass through.

Mark the wall along the bottom of the surround being sure to record the lateral position of the bottom clips. The surround may now be set down. Remove the bottom chair clips from the surround and hold against the wall on the pencil lines as shown, then mark around slotted holes. Drill in the center of the slot marks and install the chair clips in the same manner as the top clips.

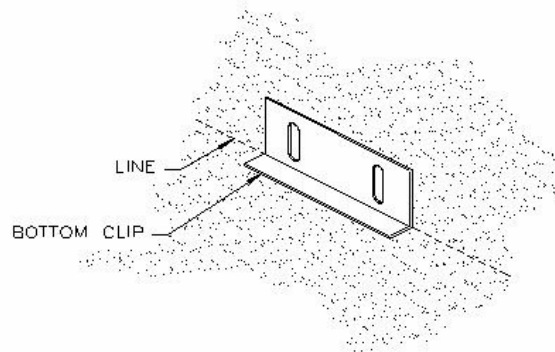

Hang the surround again and check how the bottom chairs fit. Make a note of the adjustments necessary, and remove the surround again to adjust the bottom chairs. Once the chairs fit tight against the bottom of the surround, replace the screws or re-drill if necessary. If desired, caulk the surround to the wall. This completes the mounting.

- 5. Lamping:** The surround is not shipped with lamps because they may break in shipment. The type of lamps needed are listed on a decal located on the light fixture. Replace the sign face in reverse of removal. Be sure to press hard with thumb all around the perimeter of the sign face.
- 6. Electrical connection:** Insert the plug into a standard outlet inside the ATM room. A 12 foot cord is provided. Load is approximately 1 amp, so no new or dedicated circuit is required. Do not plug in to a dedicated ATM power supply.
- 7.** Replace the suction cup on the hook provided in the lower compartment, and replace the waste can.
- 8.** Clean up with household spray cleaner. Clean up packing materials.

If there are any questions: please call **(801) 298-8082** and ask for Customer Service.

Voiding of Warranties:

These installation instructions are an integral part of the product warranties given by Companion Systems to the customer. Proper operation and maximum performance of the product depend upon proper installation. In the event that the product is installed by the customer, or by anyone performing the installation at the customer's request, in any manner other than in strict compliance with these instructions and specifications, all warranties, express or implied, are void, and all repairs, reinstallations and other modifications to the product necessary to bring the installation in compliance with these instructions shall be at the customer's sole expense.